

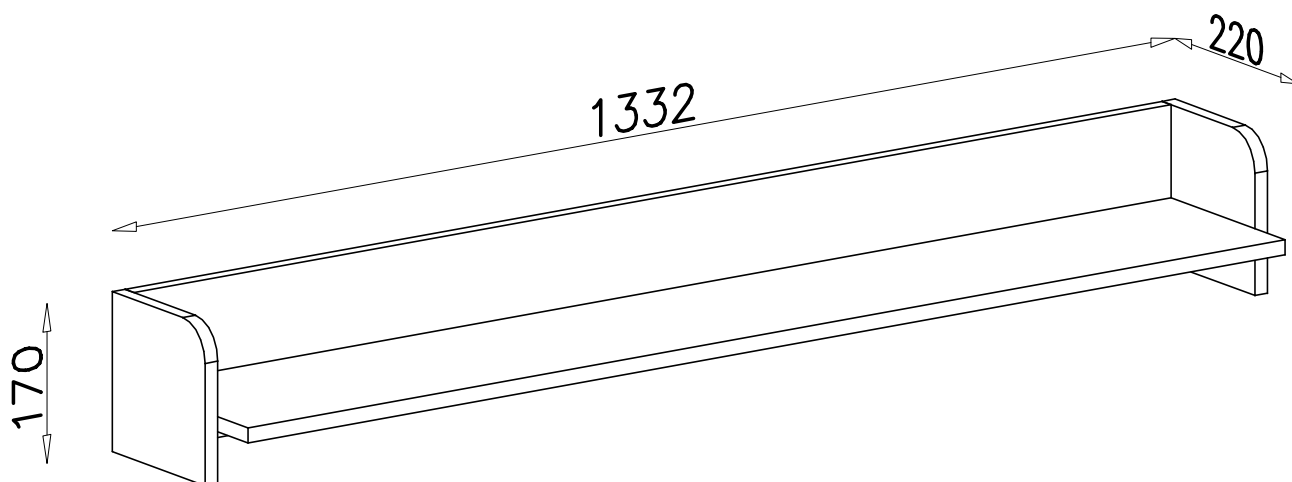

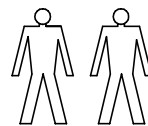

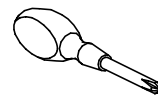

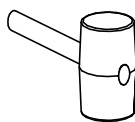

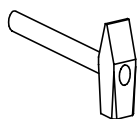
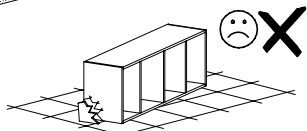
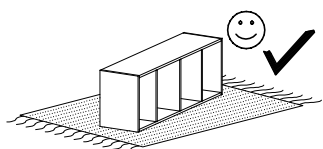

# GRANDE GR 9

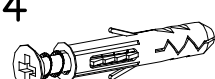

<b>W1</b>  GLUE, LEIM, LEPIDLO, LIM x1	<b>G4</b>  4x16 x4	<b>I7</b>  Ø18 x4	<b>U4</b>  x2	<b>U12</b>  x2
<b>A1</b>  Ø7x50 x5	<b>B7</b>  Ø8x30 x14	<b>W2</b>  x1	<b>K5</b>  x4	<b>K1</b>  Ø15x12 x4

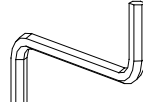
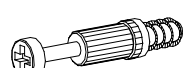